

# ISO FLANGES & FITTINGS



Fudong Machinery  
Manufacture (HK) Co, Ltd

# ISO FLANGE & TUBE

ISO flanges are specially designed for pipes with diameters above 2". They are divided into ISO-K (clamp flanges) and ISO-F (screw flanges) due to different locking tools. ISO flanges follow ISO specifications, in line with world standards.

The sealing method is the same as the KF series, and the O-ring is used to achieve the sealing effect of vacuum, and the minimum pressure can reach  $1 \times 10^{-8}$  Torr.

Clamp-type ISO flange (ISO-K) is fixed by "two-way clip screws", so there is no directional assembly interference problem in terms of combination configuration.

Screw-type ISO flange (ISO-F) adopts screws, which are evenly locked around the flange. Although there is directionality, the uniformity of combined strength and sealing is stronger than that of ISO-K.

We also make a series of adapters for the ISO series, please refer to the Adapters section of the catalog.

## Specification

APPLICATION: HIGH VACUUM  
 MATERIAL: 304/L; 316LN, AL 6061  
 Flange size range: ISO63-ISO320  
 Standard pipe diameter size range: 1/2"-6"  
 (Pipe fittings above 8" are customized)  
 Pipe Surface: sandblasting  
 Pressure range:  
 760 Torr  $\sim 1 \times 10^{-8}$  Torr  
 Gasket Material: FKM, Buna-N or Silicone  
 Temperature range: Less than 200 degrees Celsius  
 (less than 150 degrees Celsius for long-term operation)

## Cleaning and Packaging

All welding points of the product are 100% leak tested. The product is cleaned by ultrasonic cleaning equipment, and the water quality is deionized water that meets the requirements of semiconductors. Packaging environment The combination and packaging of the overall product are done in a high clean environment to ensure the cleanliness of the product.

## ISO

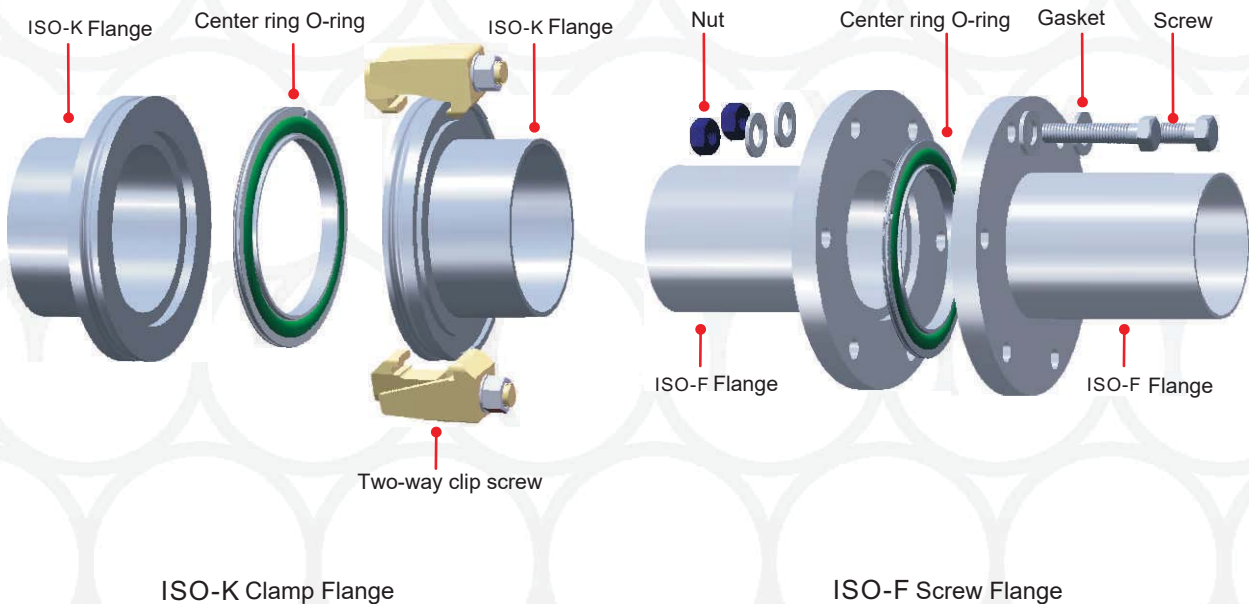

# ISO法兰与管件

ISO 法兰是专门替2"以上管径设计，其中因不同的锁附工具，分成 ISO-K (卡箍式法兰)与ISO-F (螺丝式法兰)。 ISO法兰遵循ISO规范，与世界规格接轨。

密封方式与KF系列相同，采用O型环紧迫达成封真空效果，最低压力可达 $1 \times 10^{-8}$  Torr。

卡箍式ISO法兰(ISO-K)采用“双向夹子螺丝”做固定，所以在组合配置方面，没有任何方向性的组装干涉问题。

螺丝式ISO法兰(ISO-F)采用螺丝，均匀的在法兰四周锁附，虽然有方向性，但是对于组合强度与密封的均匀性比 ISO-K来的强。

我们也针对 ISO系列作一连串的转接头，请参照目录转接头部分。

## 标准规格

应用：高真空

材质：304/L，316/L，镁铝合金AL6061

法兰尺寸范围：ISO63~ISO320

标准管件径尺寸范围：1/2" ~ 6"

(超过8"管径为客制化管道)

管件表面处理：喷砂

压力范围：760 Torr ~  $1 \times 10^{-8}$  Torr

密封垫片材质：FKM，Buna-N或硅胶

温度范围：小于摄氏200度

(长期操作小于摄氏150度)

## 清洁与包装

产品所有的焊接点100%的测漏检验，产品清洗经过超音波清洗设备清洗，水质使用合乎半导体要求去离子水。

包装环境于高洁净环境做整体产品的组合与包装，确保产品的洁净度。

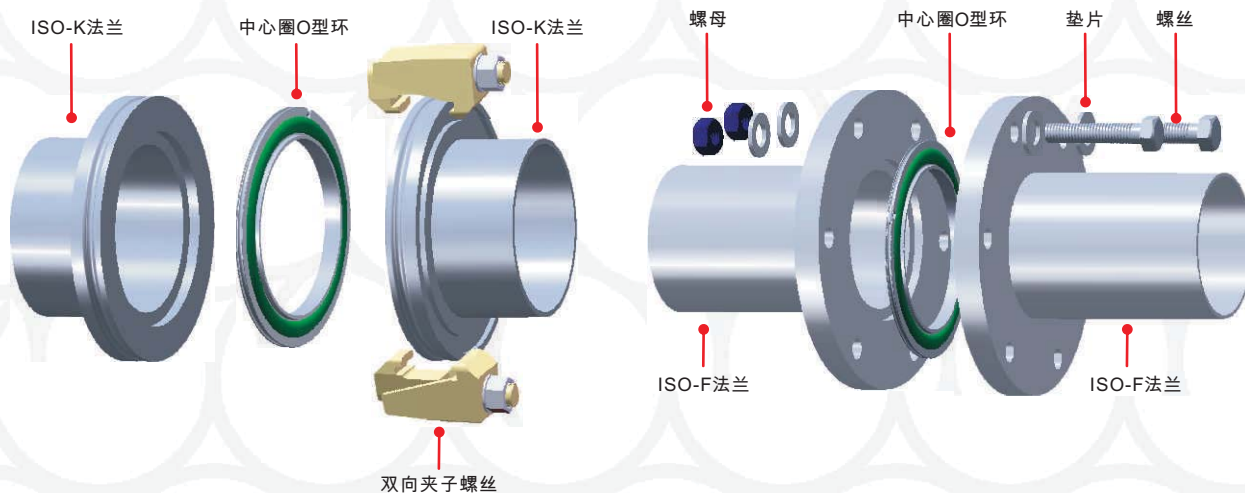

ISO-K 卡箍式法兰

ISO-F 螺丝式法兰

# ISO Flanges & Fittings

## 链式卡箍

### NW CHAIN CLAMPS

材质 ALUMINUM Material: Aluminum

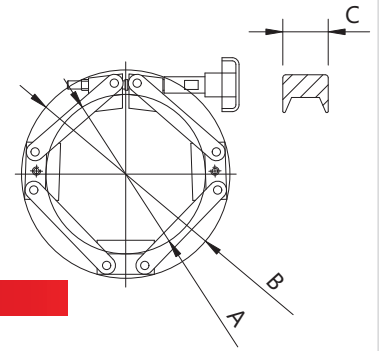

Catalogue PN	Size	A	B	C
NW-CC-63	NW63	98.00	134.40	30.00
NW-CC-80	NW80	117.10	153.00	30.00
NW-CC-100	NW100	136.50	171.68	30.00
NW-CC-160	NW160	197.90	231.70	30.00

## ISO-K 单向夹子螺丝

### ISO-K SINGLE CLAWS

材质：不锈钢304 Material: 304/L

螺丝规格：公制牙 Screw Specifications: Metric Thread

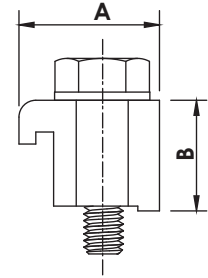

Catalogue PN	Size	A	B	Thread Size
ISOK-SC-63100M	ISO63-ISO100	24.10	22.50	M8 x 35L
ISOK-SC-160250M	ISO160-ISO250	27.50	23.50	M10 x 35L
ISOK-SC-320500M	ISO320-ISO500	30.00	30.00	M12 x 50L
ISOK-SC-630M	ISO630	30.00	35.00	M12 x 50L

## ISO-K 单向夹子螺丝

### ISO-K SINGLE CLAWS

材质：镁铝合金 Material: Magnesium aluminum alloy

螺丝规格：公制牙与英制牙 Screw Specifications: Metric Thread and Inch Thread

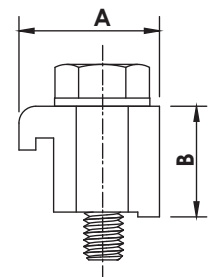

Catalogue PN	Size	A	B	Thread Size
ISOK-SC-63100M-AL	ISO63-ISO100	24.10	22.50	M8 x 35L
ISOK-SC-63100-AL	ISO63-ISO100	24.10	22.50	5/16"-18
ISOK-SC-160250M-AL	ISO160-ISO250	27.50	23.50	M10 x 35L
ISOK-SC-160250-AL	ISO160-ISO250	27.50	23.50	5/16"-18L

## ISO-K 单向夹子螺丝

### ISO-K SINGLE CLAWS

材质：铁镀锌 Material: Iron galvanized

螺丝规格：公制牙 Screw Specifications: Metric Thread

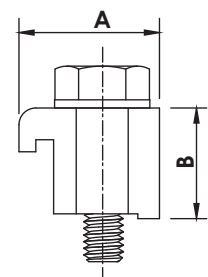

Catalogue PN	Size	A	B	Thread Size
ISOK-SC-63100M-ZP	ISO60-ISO100	24.10	22.50	M8 x 35L
ISOK-SC-160250M-ZP	ISO160-ISO250	27.50	23.50	M10 x 35L
ISOK-SC-320250M-ZP	ISO320-ISO500	30.00	30.00	M12 x 50L



# ISO Flanges & Fittings

## ISO-K 双向夹子螺丝 ISO-K DOUBLE CLAWS

材质：不锈钢304 Material: 304

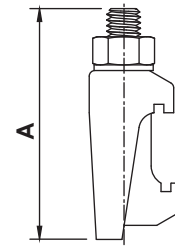

Catalogue PN	Size	A	Bolt Size
ISOK-DC-63250M	ISO63-ISO250	60.00	M10
ISOK-DC-320500M	ISO320-ISO500	76.50	M12

## ISO-K 双向夹子螺丝 ISO-K DOUBLE CLAWS

材质：铁镀锌 Material: Iron galvanized

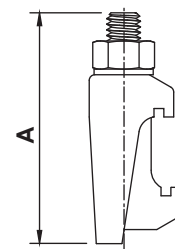

Catalogue PN	Size	A	Bolt Size
ISOK-DC-63250M-ZP	ISO63-ISO250	60.00	M10
ISOK-DC-320500M-ZP	ISO320-ISO500	76.50	M12

## ISO-K 双向夹子螺丝 ISO-K DOUBLE CLAWS

材质：铸铝 Material: cast aluminum

螺丝规格：公制牙与英制牙 Screw Specifications: Metric Thread and Inch Thread

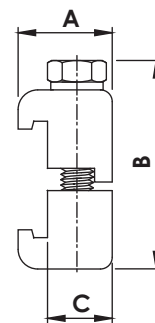

Catalogue PN	Size	A	B	C	Thread Size
ISOK-DC-63100M-AL	ISO63-ISO100	24.00	50.00	16.50	M8x45L
ISOK-DC-63100-AL	ISO63-ISO100	24.00	50.00	16.50	5/16"-18
ISOK-DC-160250M-AL	ISO160-ISO250	27.50	51.60	20.00	M10x45L
ISOK-DC-160250-AL	ISO160-ISO250	27.50	51.60	20.00	5/16"-18

ISO

# ISO Flanges & Fittings

## ISO-K 中心圈

### ISO CENTERING RINGS

材质：不锈钢304/L Material: 304/L

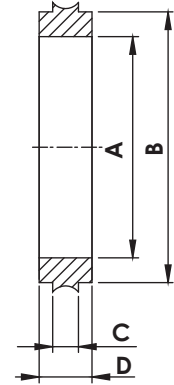

Catalogue PN	Size	A	B	C	D
ISO-CR-63	ISO63	68.00	70.00	3.90	8
ISO-CR-80	ISO80	81.00	83.00	3.90	8
ISO-CR-100	ISO100	100.00	102.00	3.90	8
ISO-CR-160	ISO160	151.00	153.00	3.90	8
ISO-CR-200	ISO200	210.00	213.00	3.90	8
ISO-CR-250	ISO250	256.00	261.00	3.90	8
ISO-CR-320	ISO320	311.15	316.48	5.50	14

NOTE: 316/L MATERIAL AVAILABLE ON REQUEST.

## ISO-K 中心圈

### ISO CENTERING RINGS, ALUMINUM

材质：镁铝合金AL6061 Material: Magnesium aluminum alloy AL 6061

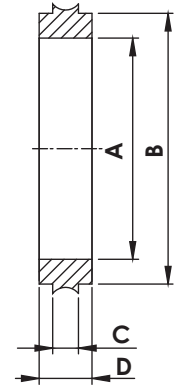

Catalogue PN	Size	A	B	C	D
ISO-CR-63-AL	ISO63	68.00	70.00	3.90	8
ISO-CR-80-AL	ISO80	81.00	83.00	3.90	8
ISO-CR-100-AL	ISO100	100.00	102.00	3.90	8
ISO-CR-160-AL	ISO160	151.00	153.00	3.90	8
ISO-CR-200-AL	ISO200	210.00	213.00	3.90	8
ISO-CR-250-AL	ISO250	256.00	261.00	3.90	8
ISO-CR-320-AL	ISO320	311.15	316.48	5.50	14

ISO

# ISO Flanges & Fittings

## ISO 中心圈O型环

### ISO CENTERING RINGS with O-RINGS

材质：不锈钢304/L Material: 304/L

O型环：FKM O ring: FKM

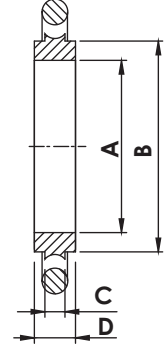

Catalogue PN	Size	A	B	C	D
ISO-CRO-63	ISO63	68.00	70.00	3.90	8
ISO-CRO-80	ISO80	81.00	83.00	3.90	8
ISO-CRO-100	ISO100	100.00	102.00	3.90	8
ISO-CRO-160	ISO160	151.00	153.00	3.90	8
ISO-CRO-200	ISO200	210.00	213.00	3.90	8
ISO-CRO-250	ISO250	256.00	261.00	3.90	8
ISO-CRO-320	ISO320	311.15	316.48	5.50	14

## ISO 中心圈O型环

### ISO CENTERING RINGS with O-RINGS, ALUMINUM

材质：镁铝合金AL6061 Material: Magnesium aluminum alloy AL 6061

O型环：FKM O ring: FKM

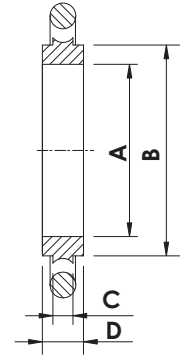

Catalogue PN	Size	A	B	C	D
ISO-CRO-63-AL	ISO63	68.00	70.00	3.90	8
ISO-CRO-80-AL	ISO80	81.00	83.00	3.90	8
ISO-CRO-100-AL	ISO100	100.00	102.00	3.90	8
ISO-CRO-160-AL	ISO160	151.00	153.00	3.90	8
ISO-CRO-200-AL	ISO200	210.00	213.00	3.90	8
ISO-CRO-250-AL	ISO250	256.00	261.00	3.90	8
ISO-CRO-320-AL	ISO320	311.15	316.48	5.50	14

## ISO 中心圈O型环耐压环

### ISO CENTERING RINGS with O-RINGS and SPACERS

材质：不锈钢304/L Material: 304/L

O型环：FKM O ring: FKM

垫圈材质：镁铝合金AL6061 Gasket Material: Magnesium aluminum alloy AL 6061

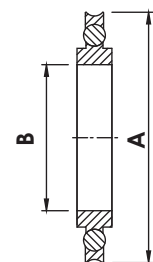

Catalogue PN	Size	A	B
ISO-CROS-63	ISO63	94.00	68.00
ISO-CROS-80	ISO80	109.00	81.00
ISO-CROS-100	ISO100	128.00	100.00
ISO-CROS-160	ISO160	179.00	151.00
ISO-CROS-200	ISO200	239.00	210.00
ISO-CROS-250	ISO250	287.00	256.00
ISO-CROS-320	ISO320	346.33	311.15
ISO-CROS-400	ISO400	428.80	392.93

NOTE: 316/L OR ALUMINUM MATERIAL AVAILABLE ON REQUEST.  
NOTE: FFKM O-RING MATERIAL AVAILABLE ON REQUEST.

ISO

# ISO Flanges & Fittings

## ISO 过滤网中心圈O型环组

### ISO SCREENED CENTERING RINGS with O-RINGS

材质：不锈钢304/L Material: 304/L

不锈钢网密度70目(一平方寸有70孔洞)

O型环：FKM

Stainless steel mesh density 70 mesh (70 holes per square inch)

O ring: FKM

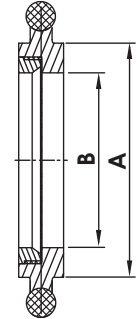

Catalogue PN	Size	A	B
ISO-CROSC-100	ISO100	102.00	92.00
ISO-CROSC-160	ISO160	153.00	139.70
ISO-CROSC-200	ISO200	213.00	206.80

## ISO O型环

### ISO REPLACEMENT O-RINGS

材质：FKM Material: FKM

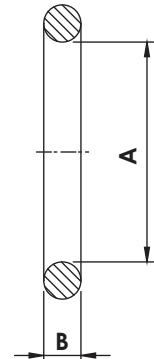

Catalogue PN	Size	A	B
ISO-RO-63	ISO63	72.39	5.33
ISO-RO-80	ISO80	85.09	5.33
ISO-RO-100	ISO100	104.14	5.33
ISO-RO-160	ISO160	151.77	5.33
ISO-RO-200	ISO200	215.27	5.33
ISO-RO-250	ISO250	266.07	5.33
ISO-RO-320	ISO320	316.87	6.99
ISO-RO-400	ISO400	393.07	6.99

NOTE: FFKM O-RING MATERIAL AVAILABLE ON REQUEST.

## ISO 耐压环

### ISO SPACER RINGS

材质：镁铝合金AL6061

Material: Magnesium aluminum alloy AL 6061

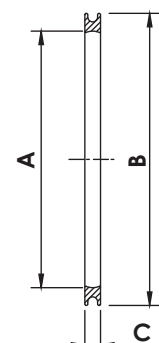

Catalogue PN	Size	A	B	C
ISO-OR-63	ISO63	88.80	98.00	3.75
ISO-OR-80	ISO80	101.80	111.00	3.75
ISO-OR-100	ISO100	120.80	130.00	3.75
ISO-OR-160	ISO160	170.10	179.30	3.75
ISO-OR-200	ISO200	232.10	241.30	3.75
ISO-OR-250	ISO250	282.10	291.30	3.75
ISO-OR-320	ISO320	335.50	344.00	5.59
ISO-OR-400	ISO400	420.30	428.80	5.59



# ISO Flanges & Fittings

## ISO-K 法兰保护盖

### ISO-K FLANGE PROTECTION CAPS, PLASTIC

材质：PE Material: PE



Catalogue PN	Size	A	B
ISOK-PC-63	ISO63	97.8	95.0
ISOK-PC-80	ISO80	113.0	110.0
ISOK-PC-100	ISO100	133.0	130.0
ISOK-PC-160	ISO160	183.0	180.0
ISOK-PC-200	ISO200	242.0	240.0
ISOK-PC-250	ISO250	293.4	290.0
ISOK-PC-320	ISO320	373.9	370.5
ISOK-PC-400	ISO400	454.2	450.8

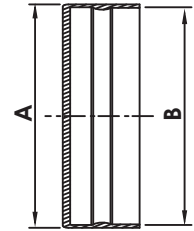

## ISO-K 盲法兰

### ISO-K BLANK FLANGES

材质：不锈钢304/L，316/L与镁铝合金AL6061  
Material: 304/L, 316L & Magnesium aluminum alloy AL 6061



Catalogue PN	Size	A	B
ISOK-BL-63	ISO63	95.00	11.90
ISOK-BL-80	ISO80	110.00	11.90
ISOK-BL-100	ISO100	130.00	11.90
ISOK-BL-160	ISO160	180.00	11.90
ISOK-BL-200	ISO200	240.00	12.00
ISOK-BL-250	ISO250	290.00	12.00
ISOK-BL-320	ISO320	370.00	17.00

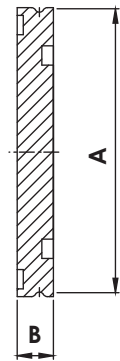

## ISO-F 盲法兰

### ISO-F BLANK FLANGES

材质：不锈钢304/L Material: 304/L



Catalogue PN	Size	A	B	Bolt Holes	PCD
ISOF-BL-63	ISO63	130.00	11.90	4	110
ISOF-BL-80	ISO80	145.00	11.90	8	125
ISOF-BL-100	ISO100	165.00	11.90	8	145
ISOF-BL-160	ISO160	225.00	16.00	8	200
ISOF-BL-200	ISO200	285.00	16.00	12	260
ISOF-BL-250	ISO250	335.00	16.00	12	310
ISOF-BL-320	ISO320	425.00	20.00	12	395

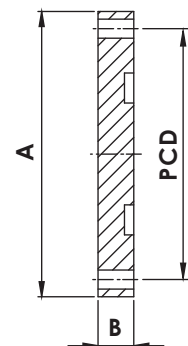

NOTE: 316/L OR ALUMINUM MATERIAL AVAILABLE ON REQUEST.

ISO

# ISO Flanges & Fittings

## ISO-K 通径法兰 ISO-K BORED FLANGES

材质：不锈钢304/L Material: 304/L

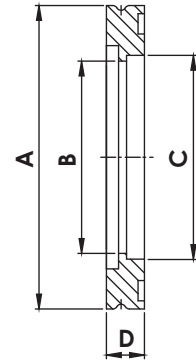

Catalogue PN	Size	A	B	C	D
ISOK-BF-63	ISO63	95.00	60.20	63.80	11.90
ISOK-BF-80	ISO80	110.00	72.90	76.50	11.90
ISOK-BF-100	ISO100	130.00	98.30	101.90	11.90
ISOK-BF-160	ISO160	180.00	149.10	152.90	11.90
ISOK-BF-200	ISO200	240.00	197.10	203.70	11.90
ISOK-BF-250	ISO250	290.00	247.70	254.50	11.90
ISOK-BF-320	ISO320	370.00	296.82	305.56	17.00

## ISO-K 半短管 ISO-K HALF NIPPLES

材质：不锈钢304/L Material: 304/L

管表面处理：喷砂 Tube surface: sandblasting

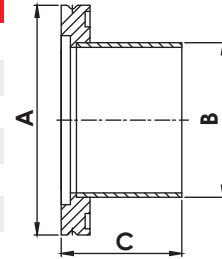

Catalogue PN	Size	A	B	C
ISOK-HN-63	ISO63	95.00	63.50	100.00
ISOK-HN-80	ISO80	110.00	76.20	100.00
ISOK-HN-100	ISO100	130.00	101.60	100.00
ISOK-HN-160	ISO160	180.00	152.40	100.00
ISOK-HN-200	ISO200	240.00	203.20	100.00
ISOK-HN-250	ISO250	290.00	254.00	100.00
ISOK-HN-320	ISO320	370.00	304.80	100.00

## ISO-F 通径法兰 ISO-F BORED FLANGES

材质：不锈钢304/L Material: 304/L

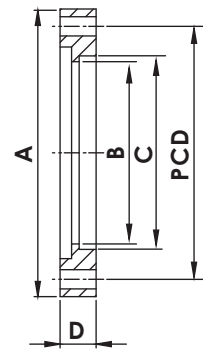

Catalogue PN	Size	A	B	C	D	PCD
ISO-F-BF-63	ISO63	130.00	61.90	63.80	11.90	110.00
ISO-F-BF-80	ISO80	145.00	74.60	76.50	11.90	125.00
ISO-F-BF-100	ISO100	165.10	99.30	101.92	11.90	145.00
ISO-F-BF-160	ISO160	225.00	149.20	152.90	16.00	200.00
ISO-F-BF-200	ISO200	285.00	200.00	203.70	16.00	260.00
ISO-F-BF-250	ISO250	335.00	250.80	254.50	16.00	310.00
ISO-F-BF-320	ISO320	425.00	318.00	324.40	20.00	395.00

## ISO-F 半短管 ISO-F HALF NIPPLES

材质：不锈钢304/L Material: 304/L

管表面处理：喷砂 Tube surface: sandblasting

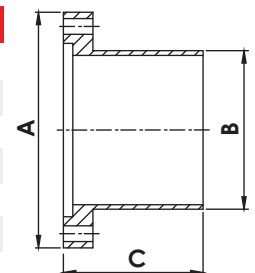

Catalogue PN	Size	A	B	C
ISO-F-HN-63	ISO63	130.00	63.50	100.00
ISO-F-HN-80	ISO80	145.00	76.20	100.00
ISO-F-HN-100	ISO100	165.10	101.60	100.00
ISO-F-HN-160	ISO160	225.00	152.40	100.00
ISO-F-HN-200	ISO200	285.00	203.20	100.00
ISO-F-HN-250	ISO250	335.00	254.00	100.00
ISO-F-HN-320	ISO320	425.00	304.80	100.00

NOTE: 316/L OR ALUMINUM MATERIAL AVAILABLE ON REQUEST.

# ISO Flanges & Fittings

## ISO-K 短管

### ISO-K FULL NIPPLES

材质：不锈钢304/L Material: 304/L

管表面处理：喷砂 Tube surface: sandblasting



Catalogue PN	Size	A	B	C
ISOK-FN-63	ISO63	ISO63	ISO63	165.10
ISOK-FN-63-1	ISO63	ISO63	ISO63	175.80
ISOK-FN-80	ISO80	ISO80	ISO80	196.10
ISOK-FN-80-1	ISO80	ISO80	ISO80	177.80
ISOK-FN-100	ISO100	ISO100	ISO100	209.80
ISOK-FN-100-1	ISO100	ISO100	ISO100	215.90
ISOK-FN-160	ISO160	ISO160	ISO160	273.30
ISOK-FN-160-1	ISO160	ISO160	ISO160	275.80

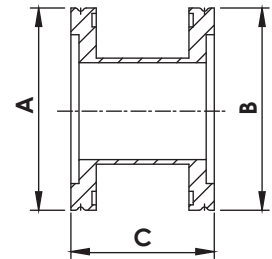

## ISO-K 直管大小头

### ISO-K REDUCER NIPPLES

材质：不锈钢304/L Material: 304/L

管表面处理：喷砂 Tube surface: sandblasting



Catalogue PN	Size	A	B	C
ISOK-SRN-80x63	ISO80x63	ISO80	ISO63	76.20
ISOK-SRN-100x63	ISO100x63	ISO100	ISO63	76.20
ISOK-SRN-100x80	ISO100x80	ISO100	ISO80	76.20
ISOK-SRN-160x63	ISO160x63	ISO160	ISO63	76.20
ISOK-SRN-160x80	ISO160x80	ISO160	ISO80	76.20
ISOK-SRN-160x100	ISO160x100	ISO160	ISO100	76.20

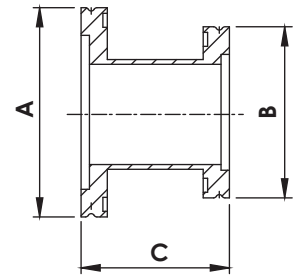

## ISO-K 同心缩径大小头

### ISO-K CONICAL REDUCERS

材质：不锈钢304/L Material: 304/L

管表面处理：喷砂 Tube surface: sandblasting



Catalogue PN	Size	A	B	C
ISOK-CRN-80x63	ISO80x63	ISO80	ISO63	104.70
ISOK-CRN-100x63	ISO100x63	ISO100	ISO63	104.70
ISOK-CRN-100x80	ISO100x80	ISO100	ISO80	104.70

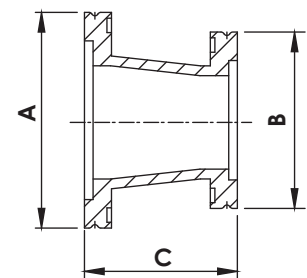

NOTE: 316/L MATERIAL AVAILABLE ON REQUEST.

NOTE: POLISHED AND ELECTRO-POLISHED TUBE FINISHES AVAILABLE ON REQUEST.

ISO

# ISO Flanges & Fittings

## ISO-K 45° 弯头

### ISO-K 45° ELBOWS

材质：不锈钢304/L Material: 304/L

管表面处理：喷砂 Tube surface: sandblasting

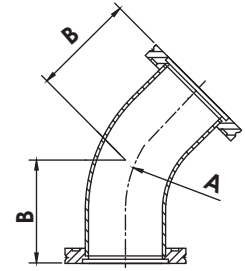

Catalogue PN	Size	A	B
ISOK-45EL-63	ISO63	95.25	82.30
ISOK-45EL-80	ISO80	114.30	100.00
ISOK-45EL-100	ISO100	152.40	128.50

## ISO-K 90° 弯头

### ISO-K 90° ELBOWS

材质：不锈钢304/L Material: 304/L

管表面处理：喷砂 Tube surface: sandblasting

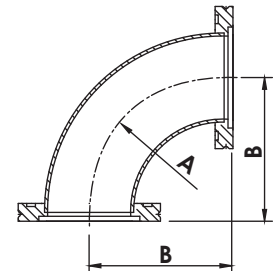

Catalogue PN	Size	A	B
ISOK-90EL-63	ISO63	95.25	101.60
ISOK-90EL-80	ISO80	114.30	120.60
ISOK-90EL-100	ISO100	152.40	158.70

## ISO-K 90° 直角弯头

### ISO-K 90° MITERED ELBOWS

材质：不锈钢304/L Material: 304/L

管表面处理：喷砂 Tube surface: sandblasting

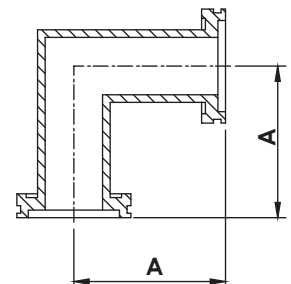

Catalogue PN	Size	A
ISOK-90MEL-63	ISO63	82.60
ISOK-90MEL-63-1	ISO63-H	87.93
ISOK-90MEL-80	ISO80	88.90
ISOK-90MEL-80-1	ISO80-H	108.00
ISOK-90MEL-100	ISO100	104.90
ISOK-90MEL-100-1	ISO100-H	108.00
ISOK-90MEL-160	ISO160	138.00
ISOK-90MEL-160-1	ISO160-H	160.20

NOTE: 316/L MATERIAL AVAILABLE ON REQUEST.

NOTE: POLISHED AND ELECTRO- POLISHED TUBE FINISHES AVAILABLE ON REQUEST.

# ISO Flanges & Fittings

## ISO-K 同径三通 ISO-K EQUAL TEES

材质：不锈钢304/L Material: 304/L

管表面处理：喷砂 Tube surface: sandblasting



Catalogue PN	Size	A	B
ISOK-ET-63	ISO63	165.00	82.50
ISOK-ET-63-1	ISO63-H	176.00	88.00
ISOK-ET-80	ISO80	177.80	88.90
ISOK-ET-80-1	ISO80-H	196.00	98.00
ISOK-ET-100	ISO100	209.40	104.70
ISOK-ET-100-1	ISO100-H	216.00	108.00
ISOK-ET-160	ISO160	266.60	133.30

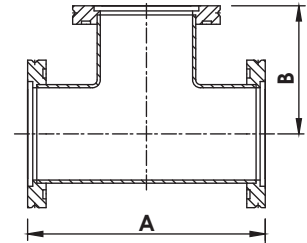

## ISO-K 异径三通 ISO-K REDUCING TEES

材质：不锈钢304/L Material: 304/L

管表面处理：喷砂 Tube surface: sandblasting



Catalogue PN	Size	A	B
ISOK-RT-80x63	ISO80xISO63	177.70	88.90
ISOK-RT-100x63	ISO100xISO63	209.70	101.60
ISOK-RT-100x80	ISO100xISO80	209.70	101.60
ISOK-RT-160x63	ISO160xISO63	266.60	126.90
ISOK-RT-160x80	ISO160xISO80	266.60	126.90
ISOK-RT-160x100	ISO160xISO100	266.60	130.30

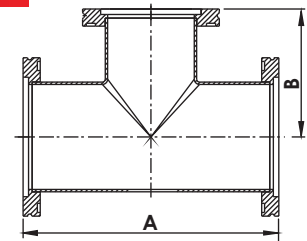

ISO

NOTE: 316/L MATERIAL AVAILABLE ON REQUEST.

NOTE: POLISHED AND ELECTRO-POLISHED TUBE FINISHES AVAILABLE ON REQUEST.

# ISO Flanges & Fittings

## ISO-K 同径四通

### ISO-K 4-WAY CROSSES

材质：不锈钢304/L Material: 304/L

管表面处理：喷砂 Tube surface: sandblasting

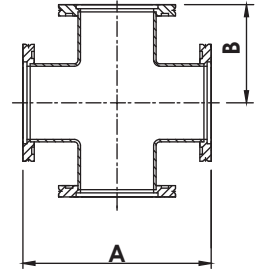

Catalogue PN	Size	A	B
ISOK-4C-63	ISO63	165.00	82.50
ISOK-4C-80	ISO80	177.80	88.90
ISOK-4C-80-1	ISO80-H	196.00	98.00
ISOK-4C-100	ISO100	209.40	104.70
ISOK-4C-100-1	ISO100-H	216.00	108.00
ISOK-4C-160	ISO160	266.60	133.30

## ISO-K 异径四通

### ISO-K 4-WAY REDUCING CROSSES

材质：不锈钢304/L Material: 304/L

管表面处理：喷砂 Tube surface: sandblasting

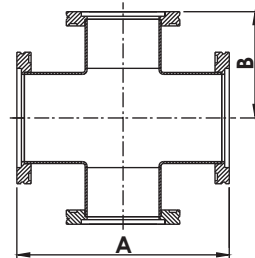

Catalogue PN	Size	A	B
ISOK-4RC-80x63	ISO80xISO63	177.70	88.85
ISOK-4RC-100x63	ISO100xISO63	209.70	101.55
ISOK-4RC-100x80	ISO100xISO80	209.70	101.55
ISOK-4RC-160x63	ISO160xISO63	266.60	126.95
ISOK-4RC-160x80	ISO160xISO80	266.60	126.95
ISOK-4RC-160x100	ISO160xISO100	266.60	130.25

NOTE: 316/L MATERIAL AVAILABLE ON REQUEST.

NOTE: POLISHED AND ELECTRO-POLISHED TUBE FINISHES AVAILABLE ON REQUEST.



# ISO Flanges & Fittings

## ISO-K 五通

### ISO-K 5-WAY CROSSES

材质：不锈钢304/L Material: 304/L

管表面处理：喷砂 Tube surface: sandblasting

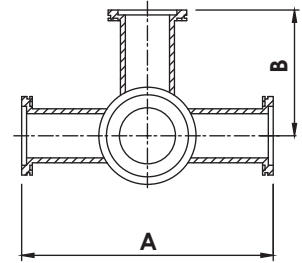

Catalogue PN	Size	A	B
ISOK-5C-63	ISO63	165.00	82.50
ISOK-5C-80	ISO80	177.80	88.90
ISOK-5C-100	ISO100	209.80	104.90
ISOK-5C-160	ISO160	266.60	133.30

## ISO-K 六通

### ISO-K 6-WAY CROSSES

材质：不锈钢304/L Material: 304/L

管表面处理：喷砂 Tube surface: sandblasting

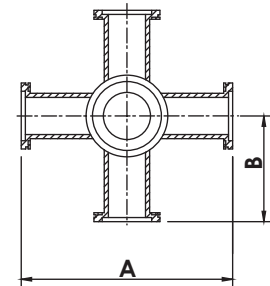

Catalogue PN	Size	A	B
ISOK-6C-63	ISO63	165.00	82.50
ISOK-6C-80	ISO80	177.80	88.90
ISOK-6C-100	ISO100	209.80	104.90
ISOK-6C-160	ISO160	266.60	133.30

ISO

NOTE: 316/L MATERIAL AVAILABLE ON REQUEST.

NOTE: POLISHED AND ELECTRO- POLISHED TUBE FINISHES AVAILABLE ON REQUEST.

# 富东机械制造(香港)有限公司

Fudong Machinery Manufacture (HK) Co, Ltd

地址: 广东省深圳市龙岗区吉华街道甘坑社区甘坑同富裕工业区 2 号 3 栋 601A1-6F

网址: <https://www.fudongmachinery.com> Email: jack@fudongmachinery.com

电话: 0755-2220 6257 传真: 0755-2220 4982

---

ShenZhen Office: 601A1-6F, Building A3, No.2, Tongfuyu Industrial Park, Gankeng, Jihua Subdistrict,  
Longgang District, Shenzhen City, Guangdong Province, China

Website: <https://www.fudongmachinery.com> Email: jack@fudongmachinery.com

Tel: +86-755-2220 6257 Fax: +86-755-2220 4982

